

$$1. (a) \int E \cdot dl = MLT^{-3}I^{-1} \times L = ML^2I^{-1}T^{-3}$$

$$(b) \oint BI = LT^{-1} \times MI^{-1}T^{-2} \times L = ML^2I^{-1}T^{-3}$$

$$(c) d\phi_s / dt = MI^{-1}T^{-2} \times L^2 = ML^2I^{-1}T^{-2}$$

$$2. \phi = at^2 + bt + c$$

$$(a) a = \left[\frac{\phi}{t^2} \right] = \left[\frac{\phi/t}{t} \right] = \frac{\text{Volt}}{\text{Sec}}$$

$$b = \left[\frac{\phi}{t} \right] = \text{Volt}$$

$$c = [\phi] = \text{Weber}$$

$$(b) E = \frac{d\phi}{dt} \quad [a = 0.2, b = 0.4, c = 0.6, t = 2s]$$

$$= 2at + b$$

$$= 2 \times 0.2 \times 2 + 0.4 = 1.2 \text{ volt}$$

$$3. (a) \phi_2 = B \cdot A = 0.01 \times 2 \times 10^{-3} = 2 \times 10^{-5}$$

$$\phi_1 = 0$$

$$e = -\frac{d\phi}{dt} = \frac{-2 \times 10^{-5}}{10 \times 10^{-3}} = -2 \text{ mV}$$

$$\phi_3 = B \cdot A = 0.03 \times 2 \times 10^{-3} = 6 \times 10^{-5}$$

$$d\phi = 4 \times 10^{-5}$$

$$e = -\frac{d\phi}{dt} = -4 \text{ mV}$$

$$\phi_4 = B \cdot A = 0.01 \times 2 \times 10^{-3} = 2 \times 10^{-5}$$

$$d\phi = -4 \times 10^{-5}$$

$$e = -\frac{d\phi}{dt} = 4 \text{ mV}$$

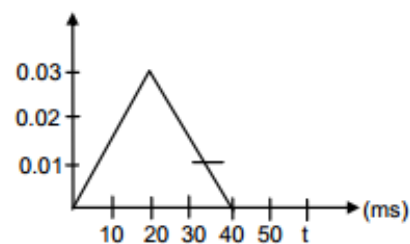

$$\phi_5 = B.A. = 0$$

$$d\phi = -2 \times 10^{-5}$$

$$e = -\frac{d\phi}{dt} = 2 \text{ mV}$$

(b) emf is not constant in case of $\rightarrow 10 - 20 \text{ ms}$ and $20 - 30 \text{ ms}$ as -4 mV and 4 mV .

$$4. \quad \phi_1 = BA = 0.5 \times \pi(5 \times 10^{-2})^2 = 5\pi \times 25 \times 10^{-5} = 125 \times 10^{-5}$$

$$\phi_2 = 0$$

$$E = \frac{\phi_1 - \phi_2}{t} = \frac{125\pi \times 10^{-5}}{5 \times 10^{-1}} = 25\pi \times 10^{-4} = 7.8 \times 10^{-3}$$

$$5. \quad A = 1 \text{ mm}^2 ; i = 10 \text{ A}, d = 20 \text{ cm} ; dt = 0.1 \text{ s}$$

$$e = \frac{d\phi}{dt} = \frac{BA}{dt} = \frac{\mu_0 i}{2\pi d} \times \frac{A}{dt}$$

$$= \frac{4\pi \times 10^{-7} \times 10}{2\pi \times 2 \times 10^{-1}} \times \frac{10^{-6}}{1 \times 10^{-1}} = 1 \times 10^{-10} \text{ V}$$

6. (a) During removal,

$$\phi_1 = B.A. = 1 \times 50 \times 0.5 \times 0.5 = 12.5 \text{ Tesla-m}^2$$

$$\phi_2 = 0, \tau = 0.25$$

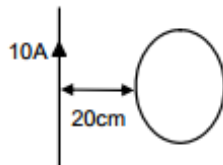

$$e = -\frac{d\phi}{dt} = \frac{\phi_2 - \phi_1}{dt} = \frac{12.5}{0.25} = \frac{125 \times 10^{-1}}{25 \times 10^{-2}} = 50V$$

(b) During its restoration

$$\phi_1 = 0 ; \phi_2 = 12.5 \text{ Tesla-m}^2 ; t = 0.25 \text{ s}$$

$$E = \frac{12.5 - 0}{0.25} = 50 \text{ V.}$$

(c) During the motion

$$\phi_1 = 0, \phi_2 = 0$$

$$E = \frac{d\phi}{dt} = 0$$

7. $R = 25 \Omega$

(a) $e = 50 \text{ V}, T = 0.25 \text{ s}$

$$i = e/R = 2A, H = i^2 RT \\ = 4 \times 25 \times 0.25 = 25 \text{ J}$$

(b) $e = 50 \text{ V}, T = 0.25 \text{ s}$

$$i = e/R = 2A, H = i^2 RT = 25 \text{ J}$$

(c) Since energy is a scalar quantity

$$\text{Net thermal energy developed} = 25 \text{ J} + 25 \text{ J} = 50 \text{ J.}$$

8. $A = 5 \text{ cm}^2 = 5 \times 10^{-4} \text{ m}^2$

$$B = B_0 \sin \omega t = 0.2 \sin(300 t)$$

$$\theta = 60^\circ$$

a) Max emf induced in the coil

$$E = -\frac{d\phi}{dt} = \frac{d}{dt}(BA \cos \theta)$$

$$= \frac{d}{dt}(B_0 \sin \omega t \times 5 \times 10^{-4} \times \frac{1}{2})$$

$$= B_0 \times \frac{5}{2} \times 10^{-4} \frac{d}{dt}(\sin \omega t) = \frac{B_0 5}{2} \times 10^{-4} \cos \omega t \cdot \omega$$

$$= \frac{0.2 \times 5}{2} \times 300 \times 10^{-4} \times \cos \omega t = 15 \times 10^{-3} \cos \omega t$$

$$E_{\max} = 15 \times 10^{-3} = 0.015 \text{ V}$$

b) Induced emf at $t = (\pi/900) \text{ s}$

$$E = 15 \times 10^{-3} \times \cos \omega t$$

$$= 15 \times 10^{-3} \times \cos (300 \times \pi/900) = 15 \times 10^{-3} \times \frac{1}{2}$$

$$= 0.015/2 = 0.0075 = 7.5 \times 10^{-3} \text{ V}$$

c) Induced emf at $t = \pi/600 \text{ s}$

$$E = 15 \times 10^{-3} \times \cos (300 \times \pi/600)$$

$$= 15 \times 10^{-3} \times 0 = 0 \text{ V.}$$

9. $\vec{B} = 0.10 \text{ T}$

$$A = 1 \text{ cm}^2 = 10^{-4} \text{ m}^2$$

$$T = 1 \text{ s}$$

$$\phi = B.A. = 10^{-1} \times 10^{-4} = 10^{-5}$$

$$e = \frac{d\phi}{dt} = \frac{10^{-5}}{1} = 10^{-5} = 10 \mu\text{V}$$

10. $E = 20 \text{ mV} = 20 \times 10^{-3} \text{ V}$

$$A = (2 \times 10^{-2})^2 = 4 \times 10^{-4}$$

$$Dt = 0.2 \text{ s}, \theta = 180^\circ$$

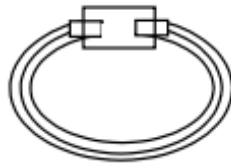

$$\phi_1 = BA, \phi_2 = -BA$$

$$d\phi = 2BA$$

$$E = \frac{d\phi}{dt} = \frac{2BA}{dt}$$

$$\Rightarrow 20 \times 10^{-3} = \frac{2 \times B \times 2 \times 10^{-4}}{2 \times 10^{-1}}$$

$$\Rightarrow 20 \times 10^{-3} = 4 \times B \times 10^{-3}$$

$$\Rightarrow B = \frac{20 \times 10^{-3}}{4 \times 10^{-3}} = 5T$$

11. Area = A, Resistance = R, B = Magnetic field

$$\phi = BA = Ba \cos 0^\circ = BA$$

$$e = \frac{d\phi}{dt} = \frac{BA}{1}; i = \frac{e}{R} = \frac{BA}{R}$$

$$\phi = iT = BA/R$$

12. $r = 2 \text{ cm} = 2 \times 10^{-2} \text{ m}$

$$n = 100 \text{ turns / cm} = 10000 \text{ turns/m}$$

$$i = 5 \text{ A}$$

$$B = \mu_0 ni$$

$$= 4\pi \times 10^{-7} \times 10000 \times 5 = 20\pi \times 10^{-3} = 62.8 \times 10^{-3} \text{ T}$$

$$n_2 = 100 \text{ turns}$$

$$R = 20 \Omega$$

$$r = 1 \text{ cm} = 10^{-2} \text{ m}$$

$$\text{Flux linking per turn of the second coil} = B\pi r^2 = B\pi \times 10^{-4}$$

$$\phi_1 = \text{Total flux linking} = Bn_2 \pi r^2 = 100 \times \pi \times 10^{-4} \times 20\pi \times 10^{-3}$$

When current is reversed.

$$\phi_2 = -\phi_1$$

$$d\phi = \phi_2 - \phi_1 = 2 \times 100 \times \pi \times 10^{-4} \times 20\pi \times 10^{-3}$$

$$E = -\frac{d\phi}{dt} = \frac{4\pi^2 \times 10^{-4}}{dt}$$

$$I = \frac{E}{R} = \frac{4\pi^2 \times 10^{-4}}{dt \times 20}$$

$$q = I dt = \frac{4\pi^2 \times 10^{-4}}{dt \times 20} \times dt = 2 \times 10^{-4} \text{ C.}$$

13. Speed = u

Magnetic field = B

Side = a

a) The perpendicular component i.e. $a \sin\theta$ is to be taken which is \perp to velocity.

$$\text{So, } l = a \sin \theta \ 30^\circ = a/2.$$

$$\text{Net 'a' charge} = 4 \times a/2 = 2a$$

$$\text{So, induced emf} = B \vartheta l = 2auB$$

$$\text{b) Current} = \frac{E}{R} = \frac{2auB}{R}$$

14. $\phi_1 = 0.35$ weber, $\phi_2 = 0.85$ weber

$$D\phi = \phi_2 - \phi_1 = (0.85 - 0.35) \text{ weber} = 0.5 \text{ weber}$$

$$dt = 0.5 \text{ sec}$$

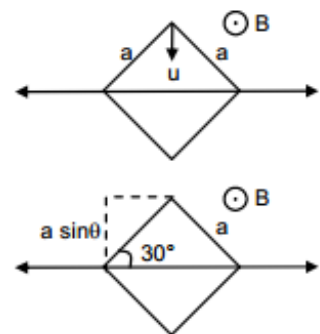

$$E = \frac{d\phi}{dt} = \frac{0.5}{0.5} = 1 \text{ v.}$$

The induced current is anticlockwise as seen from above.

15. $i = v(B \times l)$

$$= v B l \cos\theta$$

θ is angle between normal to plane and $\vec{B} = 90^\circ$.

$$= v B l \cos 90^\circ = 0.$$

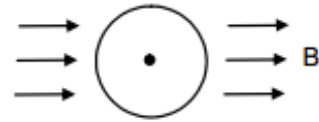

16. $u = 1 \text{ cm/s}$, $B = 0.6 \text{ T}$

a) At $t = 2 \text{ sec}$, distance moved = $2 \times 1 \text{ cm/s} = 2 \text{ cm}$

$$E = \frac{d\phi}{dt} = \frac{0.6 \times (2 \times 5 - 0) \times 10^{-4}}{2} = 3 \times 10^{-4} \text{ V}$$

b) At $t = 10 \text{ sec}$

distance moved = $10 \times 1 = 10 \text{ cm}$

The flux linked does not change with time

$$\therefore E = 0$$

c) At $t = 22 \text{ sec}$

distance = $22 \times 1 = 22 \text{ cm}$

The loop is moving out of the field and 2 cm outside.

$$E = \frac{d\phi}{dt} = B \times \frac{dA}{dt}$$

$$= \frac{0.6 \times (2 \times 5 \times 10^{-4})}{2} = 3 \times 10^{-4} \text{ V}$$

d) At $t = 30 \text{ sec}$

The loop is total outside and flux linked = 0

$$\therefore E = 0.$$

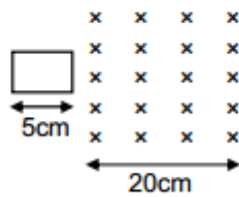

17. As heat produced is a scalar prop.

So, net heat produced = $H_a + H_b + H_c + H_d$

$$R = 4.5 \text{ m}\Omega = 4.5 \times 10^{-3} \Omega$$

a) $e = 3 \times 10^{-4} \text{ V}$

$$i = \frac{e}{R} = \frac{3 \times 10^{-4}}{4.5 \times 10^{-3}} = 6.7 \times 10^{-2} \text{ Amp.}$$

$$H_a = (6.7 \times 10^{-2})^2 \times 4.5 \times 10^{-3} \times 5$$

$$H_b = H_d = 0 \text{ [since emf is induced for 5 sec]}$$

$$H_c = (6.7 \times 10^{-2})^2 \times 4.5 \times 10^{-3} \times 5$$

So Total heat = $H_a + H_c$

$$= 2 \times (6.7 \times 10^{-2})^2 \times 4.5 \times 10^{-3} \times 5 = 2 \times 10^{-4} \text{ J.}$$

18. $r = 10 \text{ cm}$, $R = 4 \Omega$

$$\frac{dB}{dt} = 0.010 \text{ T/s}, \quad \frac{d\phi}{dt} = \frac{dB}{dt} A$$

$$E = \frac{d\phi}{dt} = \frac{dB}{dt} \times A = 0.01 \left(\frac{\pi r^2}{2} \right)$$

$$= \frac{0.01 \times 3.14 \times 0.01}{2} = \frac{3.14}{2} \times 10^{-4} = 1.57 \times 10^{-4}$$

$$i = \frac{E}{R} = \frac{1.57 \times 10^{-4}}{4} = 0.39 \times 10^{-4} = 3.9 \times 10^{-5} \text{ A}$$

19. a) S_1 closed S_2 open

$$\text{net } R = 4 \times 4 = 16 \Omega$$

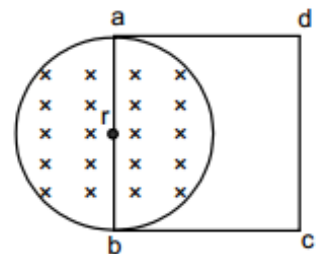

$$e = \frac{d\phi}{dt} = A \frac{dB}{dt} = 10^{-4} \times 2 \times 10^{-2} = 2 \times 10^{-6} \text{ V}$$

$$i \text{ through } ad = \frac{e}{R} = \frac{2 \times 10^{-6}}{16} = 1.25 \times 10^{-7} \text{ A along } ad$$

b) $R = 16 \Omega$

$$e = A \times \frac{dB}{dt} = 2 \times 10^{-5} \text{ V}$$

$$i = \frac{2 \times 10^{-6}}{16} = 1.25 \times 10^{-7} \text{ A along } da$$

c) Since both S_1 and S_2 are open, no current is passed as circuit is open i.e. $i = 0$

d) Since both S_1 and S_2 are closed, the circuit forms a balanced wheat stone bridge and no current will flow along ad i.e. $i = 0$.

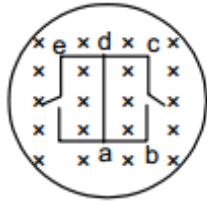

20. Magnetic field due to the coil (1) at the center of (2) is $B = \frac{\mu_0 N i a^2}{2(a^2 + x^2)^{3/2}}$

Flux linked with the second,

$$= B \cdot A_{(2)} = \frac{\mu_0 N i a^2}{2(a^2 + x^2)^{3/2}} \pi a'^2$$

20. Magnetic field due to the coil (1) at the center of (2) is $B = \frac{\mu_0 N i a^2}{2(a^2 + x^2)^{3/2}}$

Flux linked with the second,

$$= B \cdot A_{(2)} = \frac{\mu_0 N i a^2}{2(a^2 + x^2)^{3/2}} \pi a'^2$$

$$\text{E.m.f. induced } \frac{d\phi}{dt} = \frac{\mu_0 N a^2 a'^2 \pi}{2(a^2 + x^2)^{3/2}} \frac{di}{dt}$$

$$= \frac{\mu_0 N \pi a^2 a'^2}{2(a^2 + x^2)^{3/2}} \frac{d}{dt} \left(\frac{E}{(R/L)x + r} \right)$$

$$= \frac{\mu_0 N \pi a^2 a'^2}{2(a^2 + x^2)^{3/2}} E \frac{-1 \cdot R/L \cdot v}{((R/L)x + r)^2}$$

$$b) = \frac{\mu_0 N \pi a^2 a'^2}{2(a^2 + x^2)^{3/2}} \frac{ERV}{L(R/2 + r)^2} \quad (\text{for } x = L/2, R/L x = R/2)$$

a) For $x = L$

$$E = \frac{\mu_0 N \pi a^2 a'^2 R v E}{2(a^2 + x^2)^{3/2} (R + r)^2}$$

21. $N = 50$, $\vec{B} = 0.200 \text{ T}$; $r = 2.00 \text{ cm} = 0.02 \text{ m}$

$\theta = 60^\circ$, $t = 0.100 \text{ s}$

$$a) e = \frac{N d\phi}{dt} = \frac{N \times B \cdot A}{T} = \frac{NBA \cos 60^\circ}{T}$$

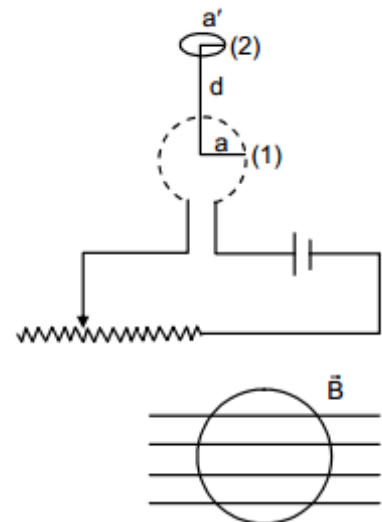

$$= \frac{50 \times 2 \times 10^{-1} \times \pi \times (0.02)^2}{0.1} = 5 \times 4 \times 10^{-3} \times \pi$$

$$= 2\pi \times 10^{-2} \text{ V} = 6.28 \times 10^{-2} \text{ V}$$

$$\text{b) } i = \frac{e}{R} = \frac{6.28 \times 10^{-2}}{4} = 1.57 \times 10^{-2} \text{ A}$$

$$Q = it = 1.57 \times 10^{-2} \times 10^{-1} = 1.57 \times 10^{-3} \text{ C}$$

22. $n = 100$ turns, $B = 4 \times 10^{-4} \text{ T}$

$$A = 25 \text{ cm}^2 = 25 \times 10^{-4} \text{ m}^2$$

a) When the coil is perpendicular to the field

$$\phi = nBA$$

When coil goes through half a turn

$$\phi = BA \cos 180^\circ = 0 - nBA$$

$$d\phi = 2nBA$$

The coil undergoes 300 rev, in 1 min

$$300 \times 2\pi \text{ rad/min} = 10 \pi \text{ rad/sec}$$

10π rad is swept in 1 sec.

$$\pi/\pi \text{ rad is swept } 1/10\pi \times \pi = 1/10 \text{ sec}$$

$$E = \frac{d\phi}{dt} = \frac{2nBA}{dt} = \frac{2 \times 100 \times 4 \times 10^{-4} \times 25 \times 10^{-4}}{1/10} = 2 \times 10^{-3} \text{ V}$$

b) $\phi_1 = nBA, \phi_2 = nBA (\theta = 360^\circ)$

$$d\phi = 0$$

c) $i = \frac{E}{R} = \frac{2 \times 10^{-3}}{4} = \frac{1}{2} \times 10^{-3}$

$$= 0.5 \times 10^{-3} = 5 \times 10^{-4}$$

$$q = idt = 5 \times 10^{-4} \times 1/10 = 5 \times 10^{-5} \text{ C.}$$

23. $r = 10 \text{ cm} = 0.1 \text{ m}$

$$R = 40 \Omega, N = 1000$$

$$\theta = 180^\circ, B_H = 3 \times 10^{-5} \text{ T}$$

$$\phi = N(B.A) = NBA \cos 180^\circ \text{ or } = -NBA$$

$$= 1000 \times 3 \times 10^{-5} \times \pi \times 1 \times 10^{-2} = 3\pi \times 10^{-4} \text{ where}$$

$$d\phi = 2NBA = 6\pi \times 10^{-4} \text{ weber}$$

$$e = \frac{d\phi}{dt} = \frac{6\pi \times 10^{-4} \text{ V}}{dt}$$

$$i = \frac{6\pi \times 10^{-4}}{40dt} = \frac{4.71 \times 10^{-5}}{dt}$$

$$Q = \frac{4.71 \times 10^{-5} \times dt}{dt} = 4.71 \times 10^{-5} \text{ C.}$$

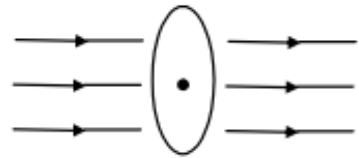

$$24. \text{ emf} = \frac{d\phi}{dt} = \frac{dB.A \cos \theta}{dt}$$

$$= B A \sin \theta \omega = -BA \omega \sin \theta$$

(dq/dt = the rate of change of angle between arc vector and B = ω)

$$a) \text{ emf maximum} = BA\omega = 0.010 \times 25 \times 10^{-4} \times 80 \times \frac{2\pi \times \pi}{6}$$

$$= 0.66 \times 10^{-3} = 6.66 \times 10^{-4} \text{ volt.}$$

b) Since the induced emf changes its direction every time,
so for the average emf = 0

$$25. H = \int_0^t i^2 R dt = \int_0^t \frac{B^2 A^2 \omega^2}{R^2} \sin^2 \omega t R dt$$

$$= \frac{B^2 A^2 \omega^2}{2R^2} \int_0^t (1 - \cos 2\omega t) dt$$

$$= \frac{B^2 A^2 \omega^2}{2R} \left(t - \frac{\sin 2\omega t}{2\omega} \right)_0^{1 \text{ minute}}$$

$$= \frac{B^2 A^2 \omega^2}{2R} \left(60 - \frac{\sin 2 \times 8 - \times 2\pi / 60 \times 60}{2 \times 80 \times 2\pi / 60} \right)$$

$$= \frac{60}{200} \times \pi^2 r^4 \times B^2 \times \left(80^4 \times \frac{2\pi}{60} \right)^2$$

$$= \frac{60}{200} \times 10 \times \frac{64}{9} \times 10 \times 625 \times 10^{-8} \times 10^{-4} = \frac{625 \times 6 \times 64}{9 \times 2} \times 10^{-11} = 1.33 \times 10^{-7} \text{ J.}$$

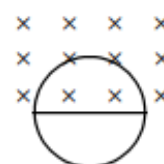

26. $\phi_1 = BA, \phi_2 = 0$

$$= \frac{2 \times 10^{-4} \times \pi (0.1)^2}{2} = \pi \times 10^{-5}$$

$$E = \frac{d\phi}{dt} = \frac{\pi \times 10^{-6}}{2} = 1.57 \times 10^{-6} \text{ V}$$

27. $l = 20 \text{ cm} = 0.2 \text{ m}$

$$v = 10 \text{ cm/s} = 0.1 \text{ m/s}$$

$$B = 0.10 \text{ T}$$

a) $F = q v B = 1.6 \times 10^{-19} \times 1 \times 10^{-1} \times 1 \times 10^{-1} = 1.6 \times 10^{-21} \text{ N}$

b) $qE = qvB$

$$\Rightarrow E = 1 \times 10^{-1} \times 1 \times 10^{-1} = 1 \times 10^{-2} \text{ V/m}$$

This is created due to the induced emf.

c) Motional emf = $Bv\ell$

$$= 0.1 \times 0.1 \times 0.2 = 2 \times 10^{-3} \text{ V}$$

28. $\ell = 1 \text{ m}, B = 0.2 \text{ T}, v = 2 \text{ m/s}, e = B\ell v$

$$= 0.2 \times 1 \times 2 = 0.4 \text{ V}$$

29. $\ell = 10 \text{ m}, v = 3 \times 10^7 \text{ m/s}, B = 3 \times 10^{-10} \text{ T}$

Motional emf = $Bv\ell$

$$= 3 \times 10^{-10} \times 3 \times 10^7 \times 10 = 9 \times 10^{-3} = 0.09 \text{ V}$$

30. $v = 180 \text{ km/h} = 50 \text{ m/s}$

$$B = 0.2 \times 10^{-4} \text{ T}, L = 1 \text{ m}$$

$$E = Bv\ell = 0.2 \times 10^{-4} \times 50 = 10^{-3} \text{ V}$$

\therefore The voltmeter will record 1 mv.

31. a) Zero as the components of ab are exactly opposite to that of bc. So they cancel each other. Because velocity should be perpendicular to the length.

b) $e = Bv \times \ell$

$= Bv (bc) +ve \text{ at } C$

c) $e = 0$ as the velocity is not perpendicular to the length.

d) $e = Bv (bc)$ positive at 'a'.

i.e. the component of 'ab' along the perpendicular direction.

32. a) Component of length moving perpendicular to V is 2R

$\therefore E = B v 2R$

b) Component of length perpendicular to velocity = 0

$\therefore E = 0$

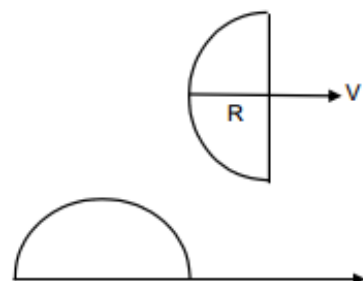
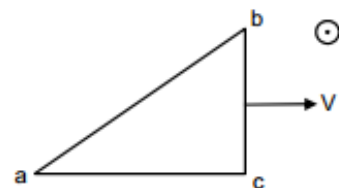

33. $\ell = 10 \text{ cm} = 0.1 \text{ m}$;

$\theta = 60^\circ$; $B = 1\text{T}$

$V = 20 \text{ cm/s} = 0.2 \text{ m/s}$

$E = Bv\ell \sin 60^\circ$

[As we have to take that component of length vector which is \perp to the velocity vector]

$= 1 \times 0.2 \times 0.1 \times \frac{\sqrt{3}}{2}$

$= 1.732 \times 10^{-2} = 17.32 \times 10^{-3} \text{ V.}$

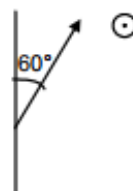

34. a) The e.m.f. is highest between diameter \perp to the velocity. Because here length \perp to velocity is highest.

$E_{\max} = VB2R$

b) The length perpendicular to velocity is lowest as the diameter is parallel to the velocity $E_{\min} = 0$.

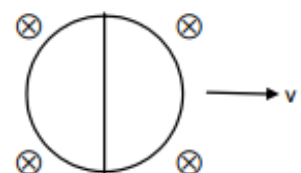

35. $F_{\text{magnetic}} = i\ell B$

This force produces an acceleration of the wire.
But since the velocity is given to be constant.
Hence net force acting on the wire must be zero.

36. $E = Bv\ell$

Resistance = $r \times$ total length
 $= r \times 2(\ell + vt) = 2r(\ell + vt)$

$$i = \frac{Bv\ell}{2r(\ell + vt)}$$

37. $e = Bv\ell$

$$i = \frac{e}{R} = \frac{Bv\ell}{2r(\ell + vt)}$$

a) $F = i\ell B = \frac{Bv\ell}{2r(\ell + vt)} \times \ell B = \frac{B^2\ell^2v}{2r(\ell + vt)}$

b) Just after $t = 0$

$$F_0 = i\ell B = \ell B \left(\frac{\ell Bv}{2r\ell} \right) = \frac{\ell B^2v}{2r}$$

$$\frac{F_0}{2} = \frac{\ell B^2v}{4r} = \frac{\ell^2 B^2v}{2r(\ell + vt)}$$

$$\Rightarrow 2\ell = \ell + vt$$

$$\Rightarrow T = \ell/v$$

38. a) When the speed is V

$$\text{Emf} = B\ell v$$

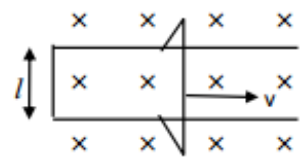
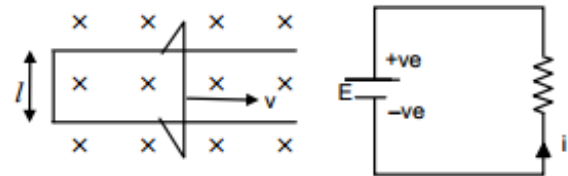
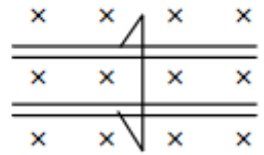

.....

Resistance = $r + R$

$$\text{Current} = \frac{B\ell v}{r + R}$$

b) Force acting on the wire = $i\ell B$

$$= \frac{B\ell v \ell B}{R + r} = \frac{B^2 \ell^2 v}{R + r}$$

$$\text{Acceleration on the wire} = \frac{B^2 \ell^2 v}{m(R + r)}$$

c) $v = v_0 + at = v_0 - \frac{B^2 \ell^2 v}{m(R + r)} t$ [force is opposite to velocity]

$$= v_0 - \frac{B^2 \ell^2 x}{m(R + r)}$$

$$\text{d) } a = v \frac{dv}{dx} = \frac{B^2 \ell^2 v}{m(R + r)}$$

$$\Rightarrow dx = \frac{dv m(R + r)}{B^2 \ell^2}$$

$$\Rightarrow x = \frac{m(R + r)v_0}{B^2 \ell^2}$$

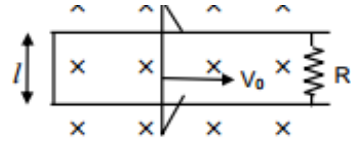

39. $R = 2.0 \Omega$, $B = 0.020 \text{ T}$, $l = 32 \text{ cm} = 0.32 \text{ m}$

$B = 8 \text{ cm} = 0.08 \text{ m}$

a) $F = i\ell B = 3.2 \times 10^{-5} \text{ N}$

$$= \frac{B^2 \ell^2 v}{R} = 3.2 \times 10^5$$

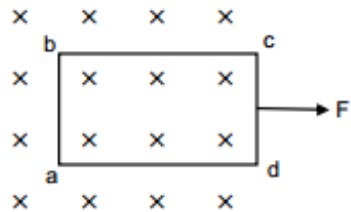

$$\tan \delta = \frac{B_v}{B_H} = \frac{1 \times 10^{-5}}{3 \times 10^{-5}} = \frac{1}{3} \Rightarrow \delta(\text{dip}) = \tan^{-1}(1/3)$$

$$41. I = \frac{B\ell v}{R} = \frac{B \times \ell \cos \theta \times v \cos \theta}{R}$$

$$= \frac{B\ell v}{R} \cos^2 \theta$$

$$F = i\ell B = \frac{B\ell v \cos^2 \theta \times \ell B}{R}$$

Now, $F = mg \sin \theta$ [Force due to gravity which pulls downwards]

$$\text{Now, } \frac{B^2 \ell^2 v \cos^2 \theta}{R} = mg \sin \theta$$

$$\Rightarrow B = \sqrt{\frac{Rmg \sin \theta}{\ell^2 v \cos^2 \theta}}$$

42. a) The wires constitute 2 parallel emf.

$$\therefore \text{Net emf} = B \ell v = 1 \times 4 \times 10^{-2} \times 5 \times 10^{-2} = 20 \times 10^{-4}$$

$$\text{Net resistance} = \frac{2 \times 2}{2 + 2} + 19 = 20 \Omega$$

$$\text{Net current} = \frac{20 \times 10^{-4}}{20} = 0.1 \text{ mA.}$$

b) When both the wires move towards opposite directions then net emf = 0

$$\therefore \text{Net current} = 0$$

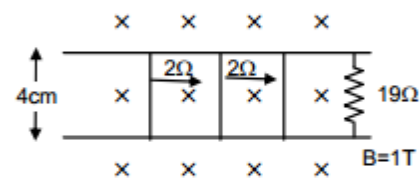
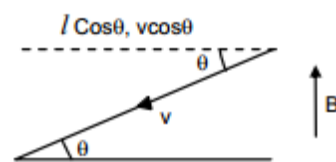
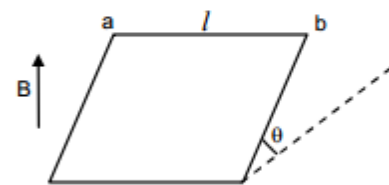

43.

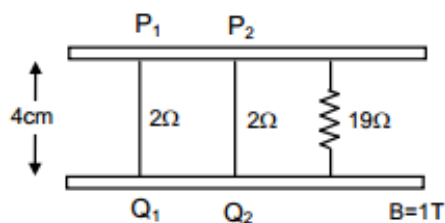

- a) No current will pass as circuit is incomplete.
 b) As circuit is complete

$$V_{P_2Q_2} = B \ell v$$

$$= 1 \times 0.04 \times 0.05 = 2 \times 10^{-3} \text{ V}$$

$$R = 2\Omega$$

$$i = \frac{2 \times 10^{-3}}{2} = 1 \times 10^{-3} \text{ A} = 1 \text{ mA.}$$

44. $B = 1 \text{ T}$, $v = 5 \times 10^{-2} \text{ m/s}$, $R = 10 \Omega$

- a) When the switch is thrown to the middle rail

$$E = Bv\ell$$

$$= 1 \times 5 \times 10^{-2} \times 2 \times 10^{-2} = 10^{-3}$$

$$\text{Current in the } 10 \Omega \text{ resistor} = E/R$$

$$= \frac{10^{-3}}{10} = 10^{-4} = 0.1 \text{ mA}$$

- b) The switch is thrown to the lower rail

$$E = Bv\ell$$

$$= 1 \times 5 \times 10^{-2} \times 2 \times 10^{-2} = 20 \times 10^{-4}$$

$$\text{Current} = \frac{20 \times 10^{-4}}{10} = 2 \times 10^{-4} = 0.2 \text{ mA}$$

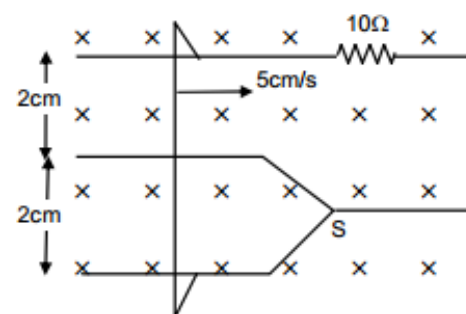
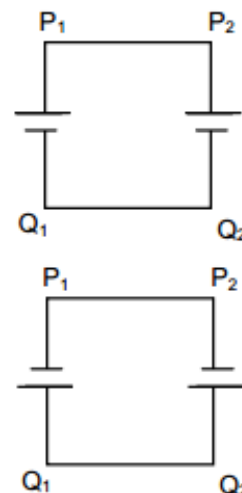

45. Initial current passing = i

Hence initial emf = ir

Emf due to motion of $ab = B\ell v$

Net emf = $ir - B\ell v$

Net resistance = $2r$

$$\text{Hence current passing} = \frac{ir - B\ell v}{2r}$$

46. Force on the wire = $i\ell B$

$$\text{Acceleration} = \frac{i\ell B}{m}$$

$$\text{Velocity} = \frac{i\ell Bt}{m}$$

47. Given $B\ell v = mg \dots(1)$

When wire is released we have

$$2mg - B\ell v = 2ma \quad [\text{where } a \rightarrow \text{acceleration}]$$

$$\Rightarrow a = \frac{2mg - B\ell v}{2m}$$

$$\text{Now, } s = ut + \frac{1}{2}at^2$$

$$\Rightarrow \ell = \frac{1}{2} \times \frac{2mg - B\ell v}{2m} \times t^2 \quad [\because s = \ell]$$

$$\Rightarrow t = \sqrt{\frac{4m\ell}{2mg - B\ell v}} = \sqrt{\frac{4m\ell}{2mg - mg}} = \sqrt{2\ell/g} \quad [\text{from (1)}]$$

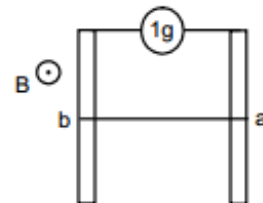
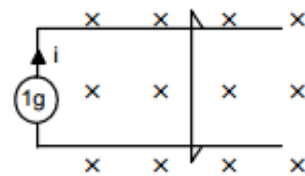
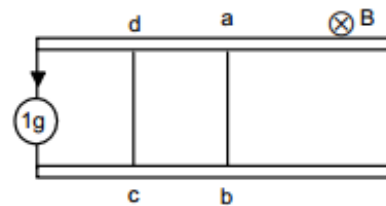

48. a) emf developed = Bdv (when it attains a speed v)

$$\text{Current} = \frac{Bdv}{R}$$

$$\text{Force} = \frac{Bd^2v^2}{R}$$

This force opposes the given force

$$\text{Net } F = F - \frac{Bd^2v^2}{R} = RF - \frac{Bd^2v^2}{R}$$

$$\text{Net acceleration} = \frac{RF - B^2d^2v}{mR}$$

b) Velocity becomes constant when acceleration is 0.

$$\frac{F}{m} - \frac{B^2d^2v_0}{mR} = 0$$

$$\Rightarrow \frac{F}{m} = \frac{B^2d^2v_0}{mR}$$

$$\Rightarrow v_0 = \frac{FR}{B^2d^2}$$

c) Velocity at time t

$$a = -\frac{dv}{dt}$$

$$\Rightarrow \int_0^v \frac{dv}{RF - B^2d^2v} = \int_0^t \frac{dt}{mR}$$

$$\Rightarrow \left[\ln[RF - B^2d^2v] \frac{1}{-B^2d^2} \right]_0^v = \left[\frac{t}{mR} \right]_0^t$$

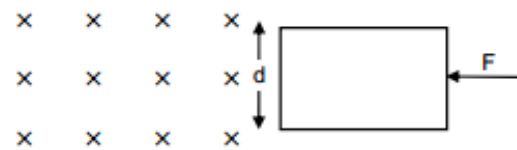

$$\Rightarrow \left[\ln(RF - l^2 B^2 v) \right]_0^v = \frac{-t^2 B^2}{R_m}$$

$$\Rightarrow \ln(RF - l^2 B^2 v) - \ln(RF) = \frac{-t^2 B^2}{R_m}$$

$$\Rightarrow 1 - \frac{l^2 B^2 v}{RF} = e^{\frac{-l^2 B^2 t}{R_m}}$$

$$\Rightarrow \frac{l^2 B^2 v}{RF} = 1 - e^{\frac{-l^2 B^2 t}{R_m}}$$

$$\Rightarrow v = \frac{FR}{l^2 B^2} \left(1 - e^{\frac{-l^2 B^2 v_0 t}{R v_0 m}} \right) = v_0 (1 - e^{-F v_0 m})$$

49. Net emf = $E - Bv\ell$

$$I = \frac{E - Bv\ell}{r} \text{ from b to a}$$

$$F = I \ell B$$

$$= \left(\frac{E - Bv\ell}{r} \right) \ell B = \frac{\ell B}{r} (E - Bv\ell) \text{ towards right.}$$

After some time when $E = Bv\ell$,

Then the wire moves constant velocity v

Hence $v = E / B\ell$.

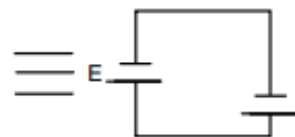
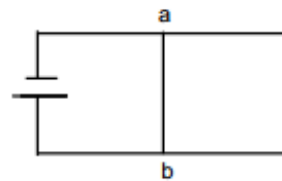

50. a) When the speed of wire is V
 emf developed = $B \ell V$

b) Induced current in the wire = $\frac{B \ell v}{R}$ (from b to a)

c) Down ward acceleration of the wire
 = $\frac{mg - F}{m}$ due to the current

$$= mg - i \ell B/m = g - \frac{B^2 \ell^2 v}{Rm}$$

d) Let the wire start moving with constant velocity. Then acceleration = 0

$$\frac{B^2 \ell^2 v}{Rm} m = g$$

$$\Rightarrow V_m = \frac{gRm}{B^2 \ell^2}$$

e) $\frac{dV}{dt} = a$

$$\Rightarrow \frac{dV}{dt} = \frac{mg - B^2 \ell^2 v / R}{m}$$

$$\Rightarrow \frac{dv}{mg - B^2 \ell^2 v / R} = dt$$

$$\Rightarrow \int_0^v \frac{mdv}{mg - \frac{B^2 \ell^2 v}{R}} = \int_0^t dt$$

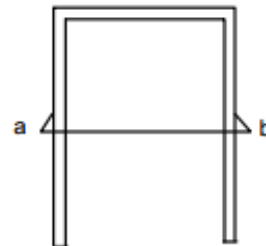

$$\Rightarrow \frac{m}{-B^2 \ell^2} \left(\log \left(mg - \frac{B^2 \ell^2 v}{R} \right) \right)'_0 = t$$

$$\Rightarrow \frac{-mR}{B^2 \ell^2} = \log \left[\log \left(mg - \frac{B^2 \ell^2 v}{R} \right) - \log(mg) \right] = t$$

$$\Rightarrow \log \left[\frac{mg - \frac{B^2 \ell^2 v}{R}}{mg} \right] = \frac{-tB^2 \ell^2}{mR}$$

$$\Rightarrow \log \left[1 - \frac{B^2 \ell^2 v}{Rmg} \right] = \frac{-tB^2 \ell^2}{mR}$$

$$\Rightarrow 1 - \frac{B^2 \ell^2 v}{Rmg} = e^{\frac{-tB^2 \ell^2}{mR}}$$

$$\Rightarrow (1 - e^{-B^2 \ell^2 / mR}) = \frac{B^2 \ell^2 v}{Rmg}$$

$$\Rightarrow v = \frac{Rmg}{B^2 \ell^2} \left(1 - e^{-B^2 \ell^2 / mR} \right)$$

$$\Rightarrow v = v_m (1 - e^{-gt/V_m}) \quad \left[v_m = \frac{Rmg}{B^2 \ell^2} \right]$$

$$f) \frac{ds}{dt} = v \Rightarrow ds = v dt$$

$$\Rightarrow s = v_m \int_0^t (1 - e^{-gt/v_m}) dt$$

$$= v_m \left(t - \frac{v_m}{g} e^{-gt/v_m} \right) = \left(v_m t + \frac{v_m^2}{g} e^{-gt/v_m} \right) - \frac{v_m^2}{g}$$

$$= v_m t - \frac{v_m^2}{g} (1 - e^{-gt/v_m})$$

$$g) \frac{d}{dt} mgs = mg \frac{ds}{dt} = mg v_m (1 - e^{-gt/v_m})$$

$$\frac{d_H}{dt} = i^2 R = R \left(\frac{\ell B v}{R} \right)^2 = \frac{\ell^2 B^2 v^2}{R}$$

$$\Rightarrow \frac{\ell^2 B^2}{R} v_m^2 (1 - e^{-gt/v_m})^2$$

After steady state i.e. $T \rightarrow \infty$

$$\frac{d}{dt} mgs = mg v_m$$

$$\frac{d_H}{dt} = \frac{\ell^2 B^2}{R} v_m^2 = \frac{\ell^2 B^2}{R} v_m \frac{mgR}{\ell^2 B^2} = mg v_m$$

Hence after steady state $\frac{d_H}{dt} = \frac{d}{dt} mgs$

51. $\ell = 0.3 \text{ m}$, $\vec{B} = 2.0 \times 10^{-5} \text{ T}$, $\omega = 100 \text{ rpm}$

$$v = \frac{100}{60} \times 2\pi = \frac{10}{3} \pi \text{ rad/s}$$

$$v = \frac{\ell}{2} \times \omega = \frac{0.3}{2} \times \frac{10}{3} \pi$$

$$\text{Emf} = e = B\ell v$$

$$= 2.0 \times 10^{-5} \times 0.3 \times \frac{0.33}{2} \times \frac{10}{3} \pi$$

$$= 3\pi \times 10^{-6} \text{ V} = 3 \times 3.14 \times 10^{-6} \text{ V} = 9.42 \times 10^{-6} \text{ V}.$$

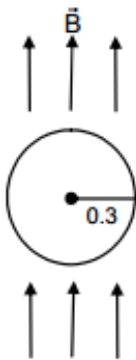

52. V at a distance $r/2$

$$\text{From the centre} = \frac{r\omega}{2}$$

$$E = B\ell v \Rightarrow E = B \times r \times \frac{r\omega}{2} = \frac{1}{2} Br^2 \omega$$

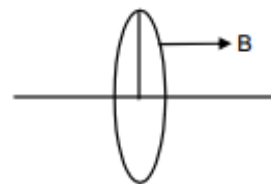

53. $B = 0.40 \text{ T}$, $\omega = 10 \text{ rad/s}$, $r = 10 \Omega$

$$r = 5 \text{ cm} = 0.05 \text{ m}$$

Considering a rod of length 0.05 m affixed at the centre and rotating with the same ω .

$$v = \frac{\ell}{2} \times \omega = \frac{0.05}{2} \times 10$$

$$e = B\ell v = 0.40 \times \frac{0.05}{2} \times 10 \times 0.05 = 5 \times 10^{-3} \text{ V}$$

$$I = \frac{e}{R} = \frac{5 \times 10^{-3}}{10} = 0.5 \text{ mA}$$

It leaves from the centre.

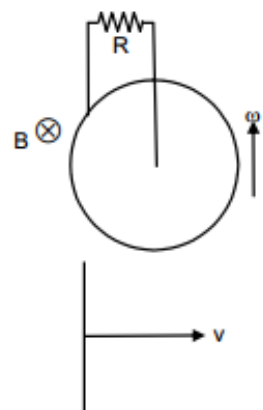

$$54. \quad \vec{B} = \frac{B_0}{L} y \hat{k}$$

L = Length of rod on y -axis

$$V = V_0 \hat{i}$$

Considering a small length dy of the rod

$$dE = B V dy$$

$$\Rightarrow dE = \frac{B_0}{L} y \times V_0 \times dy$$

$$\Rightarrow dE = \frac{B_0 V_0}{L} y dy$$

$$\Rightarrow E = \frac{B_0 V_0}{L} \int_0^L y dy$$

$$= \frac{B_0 V_0}{L} \left[\frac{y^2}{2} \right]_0^L = \frac{B_0 V_0}{L} \frac{L^2}{2} = \frac{1}{2} B_0 V_0 L$$

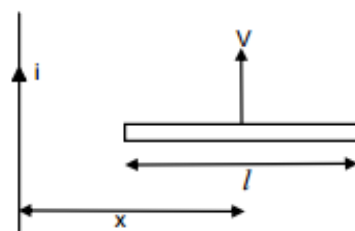

55. In this case \vec{B} varies

Hence considering a small element at centre of rod of length dx at a dist x from the wire.

$$\vec{B} = \frac{\mu_0 i}{2\pi x}$$

$$\text{So, } de = \frac{\mu_0 i}{2\pi x} \times v dx$$

$$e = \int_0^e de = \frac{\mu_0 i v}{2\pi} = \int_{x-\ell/2}^{x+\ell/2} \frac{dx}{x} = \frac{\mu_0 i v}{2\pi} [\ln(x + \ell/2) - \ln(x - \ell/2)]$$

$$= \frac{\mu_0 i v}{2\pi} \ln \left[\frac{x + \ell/2}{x - \ell/2} \right] = \frac{\mu_0 i v}{2\pi} \ln \left(\frac{2x + \ell}{2x - \ell} \right)$$

56. a) emf produced due to the current carrying wire = $\frac{\mu_0 i v}{2\pi} \ln\left(\frac{2x + \ell}{2x - \ell}\right)$

Let current produced in the rod = $i' = \frac{\mu_0 i v}{2\pi R} \ln\left(\frac{2x + \ell}{2x - \ell}\right)$

Force on the wire considering a small portion dx at a distance x

$$dF = i' B \ell$$

$$\Rightarrow dF = \frac{\mu_0 i v}{2\pi R} \ln\left(\frac{2x + \ell}{2x - \ell}\right) \times \frac{\mu_0 i}{2\pi x} \times dx$$

$$\Rightarrow dF = \left(\frac{\mu_0 i}{2\pi}\right)^2 \frac{v}{R} \ln\left(\frac{2x + \ell}{2x - \ell}\right) \frac{dx}{x}$$

$$\Rightarrow F = \left(\frac{\mu_0 i}{2\pi}\right)^2 \frac{v}{R} \ln\left(\frac{2x + \ell}{2x - \ell}\right) \int_{x-\ell/2}^{x+\ell/2} \frac{dx}{x}$$

$$= \left(\frac{\mu_0 i}{2\pi}\right)^2 \frac{v}{R} \ln\left(\frac{2x + \ell}{2x - \ell}\right) \ln\left(\frac{2x + \ell}{2x - \ell}\right)$$

$$= \frac{v}{R} \left[\frac{\mu_0 i}{2\pi} \ln\left(\frac{2x + \ell}{2x - \ell}\right) \right]^2$$

b) Current = $\frac{\mu_0 i v}{2\pi R} \ln\left(\frac{2x + \ell}{2x - \ell}\right)$

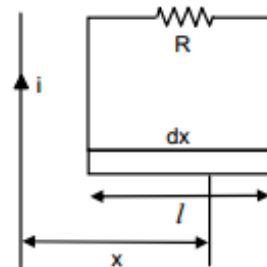

c) Rate of heat developed = $i^2 R$

$$= \left[\frac{\mu_0 i v}{2\pi R} \ln \left(\frac{2x + \ell}{2x - \ell} \right) \right]^2 R = \frac{1}{R} \left[\frac{\mu_0 i v}{2\pi} \ln \left(\frac{2x + \ell}{2x - \ell} \right) \right]^2$$

d) Power developed in rate of heat developed = $i^2 R$

$$= \frac{1}{R} \left[\frac{\mu_0 i v}{2\pi} \ln \left(\frac{2x + \ell}{2x - \ell} \right) \right]^2$$

57. Considering an element dx at a dist x from the wire. We have

a) $\phi = B.A.$

$$d\phi = \frac{\mu_0 i \times a dx}{2\pi x}$$

$$\phi = \int_0^a d\phi = \frac{\mu_0 i a}{2\pi} \int_b^{a+b} \frac{dx}{x} = \frac{\mu_0 i a}{2\pi} \ln \{1 + a/b\}$$

b) $e = \frac{d\phi}{dt} = \frac{d}{dt} \frac{\mu_0 i a}{2\pi} \ln \{1 + a/b\}$

$$= \frac{\mu_0 a}{2\pi} \ln \{1 + a/b\} \frac{d}{dt} (i_0 \sin \omega t)$$

$$= \frac{\mu_0 a i_0 \omega \cos \omega t}{2\pi} \ln \{1 + a/b\}$$

c) $i = \frac{e}{r} = \frac{\mu_0 a i_0 \omega \cos \omega t}{2\pi r} \ln \{1 + a/b\}$

$$H = i^2 r t$$

$$= \left[\frac{\mu_0 a i_0 \omega \cos \omega t}{2\pi r} \ln \{1 + a/b\} \right]^2 \times r \times t$$

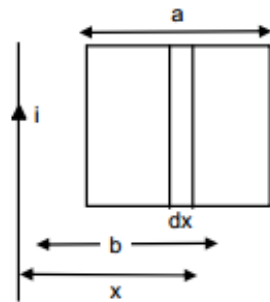

$$= \frac{\mu_0^2 \times a^2 \times i_0^2 \times \omega^2}{4\pi \times r^2} \ln^2[1+a/b] \times r \times \frac{20\pi}{\omega}$$

$$= \frac{5\mu_0^2 a^2 i_0^2 \omega}{2\pi r} \ln^2[1+a/b] \quad [\because t = \frac{20\pi}{\omega}]$$

58. a) Using Faraday's law

Consider a unit length dx at a distance x

$$B = \frac{\mu_0 i}{2\pi x}$$

Area of strip = $b dx$

$$d\phi = \frac{\mu_0 i}{2\pi x} dx$$

$$\Rightarrow \phi = \int_a^{a+l} \frac{\mu_0 i}{2\pi x} b dx$$

$$= \frac{\mu_0 i}{2\pi} b \int_a^{a+l} \left(\frac{dx}{x} \right) = \frac{\mu_0 i b}{2\pi} \log \left(\frac{a+l}{a} \right)$$

$$\text{Emf} = \frac{d\phi}{dt} = \frac{d}{dt} \left[\frac{\mu_0 i b}{2\pi} \log \left(\frac{a+l}{a} \right) \right]$$

$$= \frac{\mu_0 i b}{2\pi} \frac{a}{a+l} \left(\frac{va - (a+l)v}{a^2} \right) \quad (\text{where } da/dt = v)$$

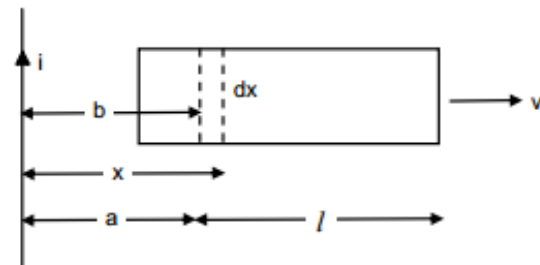

$$= \frac{\mu_0 i b}{2\pi} \frac{a}{a+l} \frac{v}{a^2} = \frac{\mu_0 i b v l}{2\pi(a+l)a}$$

The velocity of AB and CD creates the emf. since the emf due to AD and BC are equal and opposite to each other.

$$B_{AB} = \frac{\mu_0 i}{2\pi a} \quad \Rightarrow \quad \text{E.m.f. AB} = \frac{\mu_0 i}{2\pi a} b v$$

Length b, velocity v.

$$B_{CD} = \frac{\mu_0 i}{2\pi(a+l)}$$

$$\Rightarrow \text{E.m.f. CD} = \frac{\mu_0 i b v}{2\pi(a+l)}$$

Length b, velocity v.

$$\text{Net emf} = \frac{\mu_0 i}{2\pi a} b v - \frac{\mu_0 i b v}{2\pi(a+l)} = \frac{\mu_0 i b v l}{2\pi a(a+l)}$$

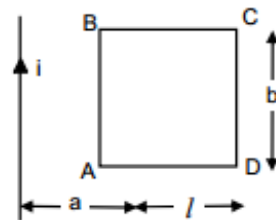

$$59. \quad e = Bvl = \frac{B \times a \times \omega \times a}{2}$$

$$i = \frac{Ba^2\omega}{2R}$$

$$F = i l B = \frac{Ba^2\omega}{2R} \times a \times B = \frac{B^2 a^3 \omega}{2R} \text{ towards right of OA.}$$

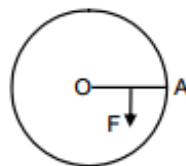

60. The 2 resistances $r/4$ and $3r/4$ are in parallel.

$$R' = \frac{r/4 \times 3r/4}{r} = \frac{3r}{16}$$

$$e = BVl$$

$$= B \times \frac{a}{2} \omega \times a = \frac{Ba^2\omega}{2}$$

$$i = \frac{e}{R'} = \frac{Ba^2\omega}{2R'} = \frac{Ba^2\omega}{2 \times 3r/16}$$

$$= \frac{Ba^2\omega 16}{2 \times 3r} = \frac{8 Ba^2\omega}{3 r}$$

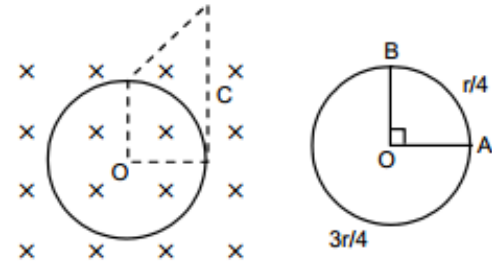

61. We know

$$F = \frac{B^2 a^2 \omega}{2R} = i l B$$

Component of mg along $F = mg \sin \theta$.

$$\text{Net force} = \frac{B^2 a^3 \omega}{2R} - mg \sin \theta.$$

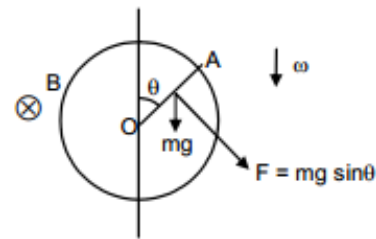

62. $\text{emf} = \frac{1}{2} B \omega a^2$ [from previous problem]

$$\text{Current} = \frac{e + E}{R} = \frac{1/2 \times B \omega a^2 + E}{R} = \frac{B \omega a^2 + 2E}{2R}$$

$$\Rightarrow mg \cos \theta = i l B \quad [\text{Net force acting on the rod is 0}]$$

$$\Rightarrow mg \cos \theta = \frac{B \omega a^2 + 2E}{2R} a \times B$$

$$\Rightarrow R = \frac{(B \omega a^2 + 2E) a B}{2mg \cos \theta}.$$

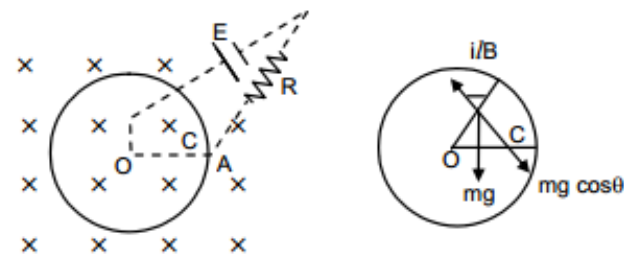

63. Let the rod has a velocity v at any instant,

Then, at the point,

$$e = B\ell v$$

$$\text{Now, } q = c \times \text{potential} = ce = CB\ell v$$

$$\text{Current } I = \frac{dq}{dt} = \frac{d}{dt} CB\ell v$$

$$= CB\ell \frac{dv}{dt} = CB\ell a \quad (\text{where } a \rightarrow \text{acceleration})$$

From figure, force due to magnetic field and gravity are opposite to each other.

$$\text{So, } mg - I\ell B = ma$$

$$\Rightarrow mg - CB\ell a \times \ell B = ma \quad \Rightarrow ma + CB^2\ell^2 a = mg$$

$$\Rightarrow a(m + CB^2\ell^2) = mg \quad \Rightarrow a = \frac{mg}{m + CB^2\ell^2}$$

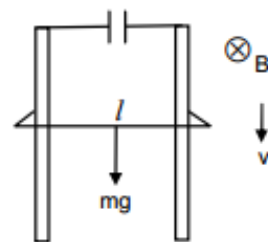

64. a) Work done per unit test charge

$$= \oint \mathbf{E} \cdot d\mathbf{l} \quad (\mathbf{E} = \text{electric field})$$

$$\oint \mathbf{E} \cdot d\mathbf{l} = e$$

$$\Rightarrow E \oint dl = \frac{d\phi}{dt} \Rightarrow E 2\pi r = \frac{dB}{dt} \times A$$

$$\Rightarrow E 2\pi r = \pi r^2 \frac{dB}{dt}$$

$$\Rightarrow E = \frac{\pi r^2}{2\pi} \frac{dB}{dt} = \frac{r}{2} \frac{dB}{dt}$$

b) When the square is considered,

$$\oint \mathbf{E} \cdot d\mathbf{l} = e$$

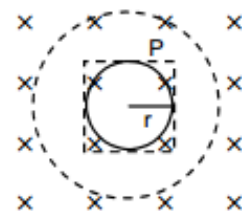

$$\Rightarrow E \times 2r \times 4 = \frac{dB}{dt} (2r)^2$$

$$\Rightarrow E = \frac{dB}{dt} \frac{4r^2}{8r} \Rightarrow E = \frac{r}{2} \frac{dB}{dt}$$

\therefore The electric field at the point p has the same value as (a).

65. $\frac{di}{dt} = 0.01 \text{ A/s}$

For 2s $\frac{di}{dt} = 0.02 \text{ A/s}$

$n = 2000 \text{ turn/m}, R = 6.0 \text{ cm} = 0.06 \text{ m}$

$r = 1 \text{ cm} = 0.01 \text{ m}$

a) $\phi = BA$

$$\Rightarrow \frac{d\phi}{dt} = \mu_0 n A \frac{di}{dt}$$

$$= 4\pi \times 10^{-7} \times 2 \times 10^3 \times \pi \times 1 \times 10^{-4} \times 2 \times 10^{-2} \quad [A = \pi \times 1 \times 10^{-4}]$$

$$= 16\pi^2 \times 10^{-10} \omega$$

$$= 157.91 \times 10^{-10} \omega$$

$$= 1.6 \times 10^{-8} \omega$$

or, $\frac{d\phi}{dt}$ for 1 s = 0.785 ω .

b) $\int E \cdot dl = \frac{d\phi}{dt}$

$$\Rightarrow E \phi dl = \frac{d\phi}{dt} \Rightarrow E = \frac{0.785 \times 10^{-8}}{2\pi \times 10^{-2}} = 1.2 \times 10^{-7} \text{ V/m}$$

$$c) \frac{d\phi}{dt} = \mu_0 n \frac{di}{dt} A = 4\pi \times 10^{-7} \times 2000 \times 0.01 \times \pi \times (0.06)^2$$

$$E \phi dl = \frac{d\phi}{dt}$$

$$\Rightarrow E = \frac{d\phi/dt}{2\pi r} = \frac{4\pi \times 10^{-7} \times 2000 \times 0.01 \times \pi \times (0.06)^2}{\pi \times 8 \times 10^{-2}} = 5.64 \times 10^{-7} \text{ V/m}$$

66. $V = 20 \text{ V}$

$$dl = I_2 - I_1 = 2.5 - (-2.5) = 5 \text{ A}$$

$$dt = 0.1 \text{ s}$$

$$V = L \frac{dl}{dt}$$

$$\Rightarrow 20 = L(5/0.1) \Rightarrow 20 = L \times 50$$

$$\Rightarrow L = 20 / 50 = 4/10 = 0.4 \text{ Henry.}$$

67. $\frac{d\phi}{dt} = 8 \times 10^{-4} \text{ weber}$

$$n = 200, I = 4 \text{ A, } E = -nL \frac{dl}{dt}$$

$$\text{or, } \frac{-d\phi}{dt} = \frac{-Ldl}{dt}$$

$$\text{or, } L = n \frac{d\phi}{dt} = 200 \times 8 \times 10^{-4} = 2 \times 10^{-2} \text{ H.}$$

$$\begin{aligned}
 68. \quad E &= \frac{\mu_0 N^2 A}{\ell} \frac{di}{dt} \\
 &= \frac{4\pi \times 10^{-7} \times (240)^2 \times \pi (2 \times 10^{-2})^2}{12 \times 10^{-2}} \times 0.8 \\
 &= \frac{4\pi \times (24)^2 \times \pi \times 4 \times 8}{12} \times 10^{-8} \\
 &= 60577.3824 \times 10^{-8} = 6 \times 10^{-4} \text{ V.}
 \end{aligned}$$

69. We know $i = i_0 (1 - e^{-t/r})$

a) $\frac{90}{100} i_0 = i_0 (1 - e^{-t/r})$

$$\Rightarrow 0.9 = 1 - e^{-t/r}$$

$$\Rightarrow e^{-t/r} = 0.1$$

Taking \ln from both sides

$$\ln e^{-t/r} = \ln 0.1 \Rightarrow -t = -2.3 \Rightarrow t/r = 2.3$$

b) $\frac{99}{100} i_0 = i_0 (1 - e^{-t/r})$

$$\Rightarrow e^{-t/r} = 0.01$$

$$\ln e^{-t/r} = \ln 0.01$$

$$\text{or, } -t/r = -4.6 \quad \text{or } t/r = 4.6$$

c) $\frac{99.9}{100} i_0 = i_0 (1 - e^{-t/r})$

$$e^{-t/r} = 0.001$$

$$\Rightarrow \ln e^{-t/r} = \ln 0.001 \Rightarrow e^{-t/r} = -6.9 \Rightarrow t/r = 6.9.$$

70. $i = 2\text{A}$, $E = 4\text{V}$, $L = 1\text{H}$

$$R = \frac{E}{i} = \frac{4}{2} = 2$$

$$i = \frac{L}{R} = \frac{1}{2} = 0.5$$

71. $L = 2.0\text{ H}$, $R = 20\ \Omega$, $\text{emf} = 4.0\text{ V}$, $t = 0.20\text{ S}$

$$i_0 = \frac{e}{R} = \frac{4}{20}, \tau = \frac{L}{R} = \frac{2}{20} = 0.1$$

$$\text{a) } i = i_0 (1 - e^{-t/\tau}) = \frac{4}{20} (1 - e^{-0.2/0.1})$$
$$= 0.17\text{ A}$$

$$\text{b) } \frac{1}{2} Li^2 = \frac{1}{2} \times 2 \times (0.17)^2 = 0.0289 = 0.03\text{ J.}$$

72. $R = 40\ \Omega$, $E = 4\text{V}$, $t = 0.1$, $i = 63\text{ mA}$

$$i = i_0 (1 - e^{-tR/L})$$

$$\Rightarrow 63 \times 10^{-3} = 4/40 (1 - e^{-0.1 \times 40/L})$$

$$\Rightarrow 63 \times 10^{-3} = 10^{-1} (1 - e^{-4/L})$$

$$\Rightarrow 63 \times 10^{-2} = (1 - e^{-4/L})$$

$$\Rightarrow 1 - 0.63 = e^{-4/L} \Rightarrow e^{-4/L} = 0.37$$

$$\Rightarrow -4/L = \ln(0.37) = -0.994$$

$$\Rightarrow L = \frac{-4}{-0.994} = 4.024\text{ H} = 4\text{ H.}$$

73. $L = 5.0 \text{ H}$, $R = 100 \Omega$, $\text{emf} = 2.0 \text{ V}$
 $t = 20 \text{ ms} = 20 \times 10^{-3} \text{ s} = 2 \times 10^{-2} \text{ s}$

$$i_0 = \frac{2}{100} \quad \text{now } i = i_0 (1 - e^{-t/\tau})$$

$$\tau = \frac{L}{R} = \frac{5}{100} \Rightarrow i = \frac{2}{100} \left(1 - e^{\frac{-2 \times 10^{-2} \times 100}{5}} \right)$$

$$\Rightarrow i = \frac{2}{100} (1 - e^{-2/5})$$

$$\Rightarrow 0.00659 = 0.0066.$$

$$V = iR = 0.0066 \times 100 = 0.66 \text{ V}.$$

74. $\tau = 40 \text{ ms}$

$$i_0 = 2 \text{ A}$$

- a) $t = 10 \text{ ms}$

$$i = i_0 (1 - e^{-t/\tau}) = 2(1 - e^{-10/40}) = 2(1 - e^{-1/4}) \\ = 2(1 - 0.7788) = 2(0.2211) = 0.4422 \text{ A} = 0.44 \text{ A}$$

- b) $t = 20 \text{ ms}$

$$i = i_0 (1 - e^{-t/\tau}) = 2(1 - e^{-20/40}) = 2(1 - e^{-1/2}) \\ = 2(1 - 0.606) = 0.7869 \text{ A} = 0.79 \text{ A}$$

- c) $t = 100 \text{ ms}$

$$i = i_0 (1 - e^{-t/\tau}) = 2(1 - e^{-100/40}) = 2(1 - e^{-10/4}) \\ = 2(1 - 0.082) = 1.835 \text{ A} = 1.8 \text{ A}$$

- d) $t = 1 \text{ s}$

$$i = i_0 (1 - e^{-t/\tau}) = 2(1 - e^{-1/40 \times 10^{-3}}) = 2(1 - e^{-10/40}) \\ = 2(1 - e^{-25}) = 2 \times 1 = 2 \text{ A}$$

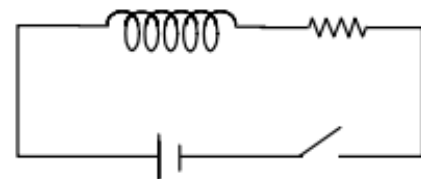

75. $L = 1.0 \text{ H}$, $R = 20 \Omega$, $\text{emf} = 2.0 \text{ V}$

$$\tau = \frac{L}{R} = \frac{1}{20} = 0.05$$

$$i_0 = \frac{e}{R} = \frac{2}{20} = 0.1 \text{ A}$$

$$i = i_0 (1 - e^{-t/\tau}) = i_0 - i_0 e^{-t/\tau}$$

$$\Rightarrow \frac{di}{dt} = \frac{di_0}{dt} (i_0 \times -1/\tau \times e^{-t/\tau}) = i_0 / \tau e^{-t/\tau} .$$

So,

$$\text{a) } t = 100 \text{ ms} \Rightarrow \frac{di}{dt} = \frac{0.1}{0.05} \times e^{-0.1/0.05} = 0.27 \text{ A}$$

$$\text{b) } t = 200 \text{ ms} \Rightarrow \frac{di}{dt} = \frac{0.1}{0.05} \times e^{-0.2/0.05} = 0.0366 \text{ A}$$

$$\text{c) } t = 1 \text{ s} \Rightarrow \frac{di}{dt} = \frac{0.1}{0.05} \times e^{-1/0.05} = 4 \times 10^{-9} \text{ A}$$

76. a) For first case at $t = 100 \text{ ms}$

$$\frac{di}{dt} = 0.27$$

$$\text{Induced emf} = L \frac{di}{dt} = 1 \times 0.27 = 0.27 \text{ V}$$

b) For the second case at $t = 200 \text{ ms}$

$$\frac{di}{dt} = 0.036$$

$$\text{Induced emf} = L \frac{di}{dt} = 1 \times 0.036 = 0.036 \text{ V}$$

c) For the third case at $t = 1$ s

$$\frac{di}{dt} = 4.1 \times 10^{-9} \text{ V}$$

$$\text{Induced emf} = L \frac{di}{dt} = 4.1 \times 10^{-9} \text{ V}$$

77. $L = 20$ mH; $e = 5.0$ V, $R = 10 \Omega$

$$\tau = \frac{L}{R} = \frac{20 \times 10^{-3}}{10}, i_0 = \frac{5}{10}$$

$$i = i_0(1 - e^{-t/\tau})^2$$

$$\Rightarrow i = i_0 - i_0 e^{-t/\tau^2}$$

$$\Rightarrow iR = i_0R - i_0R e^{-t/\tau^2}$$

$$\text{a) } 10 \times \frac{di}{dt} = \frac{d}{dt} i_0R + 10 \times \frac{5}{10} \times \frac{10}{20 \times 10^{-3}} \times e^{-0 \times 10 / 2 \times 10^{-2}}$$

$$= \frac{5}{2} \times 10^{-3} \times 1 = \frac{5000}{2} = 2500 = 2.5 \times 10^{-3} \text{ V/s.}$$

$$\text{b) } \frac{Rdi}{dt} = R \times i_0 \times \frac{1}{\tau} \times e^{-t/\tau}$$

$$t = 10 \text{ ms} = 10 \times 10^{-3} \text{ s}$$

$$\frac{dE}{dt} = 10 \times \frac{5}{10} \times \frac{10}{20 \times 10^{-3}} \times e^{-0.01 \times 10 / 2 \times 10^{-2}}$$

$$= 16.844 = 17 \text{ V/s}$$

c) For $t = 1$ s

$$\frac{dE}{dt} = \frac{R di}{dt} = \frac{5}{2} 10^3 \times e^{10/2 \times 10^{-2}} = 0.00 \text{ V/s.}$$

78. $L = 500$ mH, $R = 25 \Omega$, $E = 5$ V

a) $t = 20$ ms

$$\begin{aligned} i &= i_0 (1 - e^{-tR/L}) = \frac{E}{R} (1 - e^{-tR/L}) \\ &= \frac{5}{25} \left(1 - e^{-20 \times 10^{-3} \times 25 / 500 \times 10^{-3}} \right) = \frac{1}{5} (1 - e^{-1}) \\ &= \frac{1}{5} (1 - 0.3678) = 0.1264 \end{aligned}$$

Potential difference $iR = 0.1264 \times 25 = 3.1606$ V = 3.16 V.

b) $t = 100$ ms

$$\begin{aligned} i &= i_0 (1 - e^{-tR/L}) = \frac{E}{R} (1 - e^{-tR/L}) \\ &= \frac{5}{25} \left(1 - e^{-100 \times 10^{-3} \times 25 / 500 \times 10^{-3}} \right) = \frac{1}{5} (1 - e^{-5}) \\ &= \frac{1}{5} (1 - 0.0067) = 0.19864 \end{aligned}$$

Potential difference = $iR = 0.19864 \times 25 = 4.9665 = 4.97$ V.

c) $t = 1$ sec

$$\begin{aligned} i &= i_0 (1 - e^{-tR/L}) = \frac{E}{R} (1 - e^{-tR/L}) \\ &= \frac{5}{25} \left(1 - e^{-1 \times 25 / 500 \times 10^{-3}} \right) = \frac{1}{5} (1 - e^{-50}) \end{aligned}$$

$$= \frac{5}{25} \left(1 - e^{-1 \times 25 / 100 \times 10^{-3}} \right) = \frac{1}{5} (1 - e^{-50})$$

$$= \frac{1}{5} \times 1 = 1/5 \text{ A}$$

Potential difference = $iR = (1/5 \times 25) \text{ V} = 5 \text{ V}$.

79. $L = 120 \text{ mH} = 0.120 \text{ H}$

$R = 10 \Omega$, $\text{emf} = 6$, $r = 2$

$$i = i_0 (1 - e^{-t/\tau})$$

Now, $dQ = idt$

$$= i_0 (1 - e^{-t/\tau}) dt$$

$$Q = \int dQ = \int_0^1 i_0 (1 - e^{-t/\tau}) dt$$

$$= i_0 \left[\int_0^t dt - \int_0^t e^{-t/\tau} dt \right] = i_0 \left[t - (-\tau) \int_0^t e^{-t/\tau} dt \right]$$

$$= i_0 [t + \tau(e^{-t/\tau-1})] = i_0 [t + \tau e^{-t/\tau}]$$

$$\text{Now, } i_0 = \frac{6}{10+2} = \frac{6}{12} = 0.5 \text{ A}$$

$$\tau = \frac{L}{R} = \frac{0.120}{12} = 0.01$$

a) $t = 0.01 \text{ s}$

$$\text{So, } Q = 0.5 [0.01 + 0.01 e^{-0.01/0.01} - 0.01]$$

$$= 0.00183 = 1.8 \times 10^{-3} \text{ C} = 1.8 \text{ mC}$$

b) $t = 20 \text{ ms} = 2 \times 10^{-2} \text{ s}$
 So, $Q = 0.5[0.02 + 0.01 e^{-0.02/0.01} - 0.01]$
 $= 0.005676 = 5.6 \times 10^{-3} \text{ C} = 5.6 \text{ mC}$

c) $t = 100 \text{ ms} = 0.1 \text{ s}$
 So, $Q = 0.5[0.1 + 0.01 e^{-0.1/0.01} - 0.01]$
 $= 0.045 \text{ C} = 45 \text{ mC}$

80. $L = 17 \text{ mH}$, $\ell = 100 \text{ m}$, $A = 1 \text{ mm}^2 = 1 \times 10^{-6} \text{ m}^2$, $f_{cu} = 1.7 \times 10^{-8} \Omega\text{-m}$

$$R = \frac{f_{cu} \ell}{A} = \frac{1.7 \times 10^{-8} \times 100}{1 \times 10^{-6}} = 1.7 \Omega$$

$$i = \frac{L}{R} = \frac{0.17 \times 10^{-8}}{1.7} = 10^{-2} \text{ sec} = 10 \text{ m sec.}$$

81. $\tau = L/R = 50 \text{ ms} = 0.05 \text{ s}$

a) $\frac{i_0}{2} = i_0(1 - e^{-t/0.06})$

$$\Rightarrow \frac{1}{2} = 1 - e^{-t/0.05} = e^{-t/0.05} = \frac{1}{2}$$

$$\Rightarrow \ln e^{-t/0.05} = \ln 1/2$$

$$\Rightarrow t = 0.05 \times 0.693 = 0.03465 \text{ s} = 34.6 \text{ ms} = 35 \text{ ms.}$$

b) $P = i^2 R = \frac{E^2}{R} (1 - e^{-tR/L})^2$

$$\text{Maximum power} = \frac{E^2}{R}$$

$$\text{So, } \frac{E^2}{2R} = \frac{E^2}{R} (1 - e^{-tR/L})^2$$

$$\Rightarrow 1 - e^{-tR/L} = \frac{1}{\sqrt{2}} = 0.707$$

$$\Rightarrow e^{-tR/L} = 0.293$$

$$\Rightarrow \frac{tR}{L} = -\ln 0.293 = 1.2275$$

$$\Rightarrow t = 50 \times 1.2275 \text{ ms} = 61.2 \text{ ms.}$$

82. Maximum current = $\frac{E}{R}$

In steady state magnetic field energy stored = $\frac{1}{2} L \frac{E^2}{R^2}$

The fourth of steady state energy = $\frac{1}{8} L \frac{E^2}{R^2}$

One half of steady energy = $\frac{1}{4} L \frac{E^2}{R^2}$

$$\frac{1}{8} L \frac{E^2}{R^2} = \frac{1}{2} L \frac{E^2}{R^2} (1 - e^{-t_1 R/L})^2$$

$$\Rightarrow 1 - e^{t_1 R/L} = \frac{1}{2}$$

$$\Rightarrow e^{t_1 R/L} = \frac{1}{2} \Rightarrow t_1 \frac{R}{L} = \ln 2 \Rightarrow t_1 = \tau \ln 2$$

Again $\frac{1}{4} L \frac{E^2}{R^2} = \frac{1}{2} L \frac{E^2}{R^2} (1 - e^{-t_2 R/L})^2$

$$\Rightarrow e^{t_2 R/L} = \frac{\sqrt{2}-1}{\sqrt{2}} = \frac{2-\sqrt{2}}{2}$$

$$\Rightarrow t_2 = \tau \left[\ln \left(\frac{1}{2-\sqrt{2}} \right) + \ln 2 \right]$$

$$\text{So, } t_2 - t_1 = \tau \ln \frac{1}{2-\sqrt{2}}$$

83. $L = 4.0 \text{ H}$, $R = 10 \Omega$, $E = 4 \text{ V}$

a) Time constant $= \tau = \frac{L}{R} = \frac{4}{10} = 0.4 \text{ s}$.

b) $i = 0.63 i_0$

$$\text{Now, } 0.63 i_0 = i_0 (1 - e^{-t/\tau})$$

$$\Rightarrow e^{-t/\tau} = 1 - 0.63 = 0.37$$

$$\Rightarrow \ln e^{-t/\tau} = \ln 0.37$$

$$\Rightarrow -t/\tau = -0.9942$$

$$\Rightarrow t = 0.9942 \times 0.4 = 0.3977 = 0.40 \text{ s}$$

c) $i = i_0 (1 - e^{-t/\tau})$

$$\Rightarrow \frac{4}{10} (1 - e^{-0.4/0.4}) = 0.4 \times 0.6321 = 0.2528 \text{ A}$$

$$\text{Power delivered} = VI$$

$$= 4 \times 0.2528 = 1.01 = 1 \text{ W}$$

d) Power dissipated in Joule heating $= I^2 R$

$$= (0.2528)^2 \times 10 = 0.639 = 0.64 \text{ W}$$

$$84. i = i_0(1 - e^{-t/\tau})$$

$$\Rightarrow \mu_0 n i = \mu_0 n i_0(1 - e^{-t/\tau})$$

$$\Rightarrow 0.8 B_0 = B_0(1 - e^{-20 \times 10^{-5} \times R / 2 \times 10^{-3}})$$

$$\Rightarrow e^{-R/100} = 0.2$$

$$\Rightarrow -R/100 = -1.609$$

$$\Rightarrow B = B_0(1 - e^{-IR/L})$$

$$\Rightarrow 0.8 = (1 - e^{-R/100})$$

$$\Rightarrow \ln(e^{-R/100}) = \ln(0.2)$$

$$\Rightarrow R = 16.9 = 160 \Omega.$$

85. Emf = E LR circuit

a) $dq = idt$

$$= i_0(1 - e^{-t/\tau})dt$$

$$= i_0(1 - e^{-IR/L})dt \quad [\because \tau = L/R]$$

$$Q = \int_0^t dq = i_0 \left[\int_0^t dt - \int_0^t e^{-IR/L} dt \right]$$

$$= i_0 [t - (-L/R)(e^{-IR/L}) t_0]$$

$$= i_0 [t - L/R(1 - e^{-IR/L})]$$

$$Q = E/R [t - L/R(1 - e^{-IR/L})]$$

b) Similarly as we know work done = VI = EI

$$= E i_0 [t - L/R(1 - e^{-IR/L})]$$

$$= \frac{E^2}{R} [t - L/R(1 - e^{-IR/L})]$$

c) $H = \int_0^t i^2 R \cdot dt = \frac{E^2}{R^2} \cdot R \cdot \int_0^t (1 - e^{-IR/L})^2 \cdot dt$

$$= \frac{E^2}{R} \int_0^t (1 + e^{(-2+2B)/L} - 2e^{-IR/L}) \cdot dt$$

$$\begin{aligned}
&= \frac{E^2}{R} \left(t - \frac{L}{2R} e^{-2tR/L} + \frac{L}{R} 2 \cdot e^{-tR/L} \right)_0^t \\
&= \frac{E^2}{R} \left(t - \frac{L}{2R} e^{-2tR/L} + \frac{2L}{R} \cdot e^{-tR/L} \right) - \left(-\frac{L}{2R} + \frac{2L}{R} \right) \\
&= \frac{E^2}{R} \left[\left(t - \frac{L}{2R} x^2 + \frac{2L}{R} \cdot x \right) - \frac{3L}{2R} \right] \\
&= \frac{E^2}{2} \left(t - \frac{L}{2R} (x^2 - 4x + 3) \right)
\end{aligned}$$

d) $E = \frac{1}{2} Li^2$

$$\begin{aligned}
&= \frac{1}{2} L \cdot \frac{E^2}{R^2} \cdot (1 - e^{-tR/L})^2 \quad [x = e^{-tR/L}] \\
&= \frac{LE^2}{2R^2} (1-x)^2
\end{aligned}$$

e) Total energy used as heat as stored in magnetic field

$$\begin{aligned}
&= \frac{E^2}{R} T - \frac{E^2}{R} \cdot \frac{L}{2R} x^2 + \frac{E^2 L}{R} \cdot 4x^2 - \frac{3L}{2R} \cdot \frac{E^2}{R} + \frac{LE^2}{2R^2} + \frac{LE^2}{2R^2} x^2 - \frac{LE^2}{R^2} x \\
&= \frac{E^2}{R} t + \frac{E^2 L}{R^2} x - \frac{LE^2}{R^2} \\
&= \frac{E^2}{R} \left(t - \frac{L}{R} (1-x) \right)
\end{aligned}$$

= Energy drawn from battery.

(Hence conservation of energy holds good).

86. $L = 2\text{H}$, $R = 200\ \Omega$, $E = 2\text{ V}$, $t = 10\text{ ms}$

a) $i = i_0 (1 - e^{-t/\tau})$

$$= \frac{2}{200} (1 - e^{-10 \times 10^{-3} \times 200 / 2})$$

$$= 0.01 (1 - e^{-1}) = 0.01 (1 - 0.3678)$$

$$= 0.01 \times 0.632 = 6.3\text{ A.}$$

b) Power delivered by the battery

$$= VI$$

$$= EI_0 (1 - e^{-t/\tau}) = \frac{E^2}{R} (1 - e^{-t/\tau})$$

$$= \frac{2 \times 2}{200} (1 - e^{-10 \times 10^{-3} \times 200 / 2}) = 0.02 (1 - e^{-1}) = 0.1264 = 12\text{ mw.}$$

c) Power dissipated in heating the resistor $= I^2 R$

$$= [i_0 (1 - e^{-t/\tau})]^2 R$$

$$= (6.3\text{ mA})^2 \times 200 = 6.3 \times 6.3 \times 200 \times 10^{-6}$$

$$= 79.38 \times 10^{-4} = 7.938 \times 10^{-3} = 8\text{ mA.}$$

d) Rate at which energy is stored in the magnetic field

$$d/dt (1/2 LI^2)$$

$$= \frac{LI_0^2}{\tau} (e^{-t/\tau} - e^{-2t/\tau}) = \frac{2 \times 10^{-4}}{10^{-2}} (e^{-1} - e^{-2})$$

$$= 2 \times 10^{-2} (0.2325) = 0.465 \times 10^{-2}$$

$$= 4.6 \times 10^{-3} = 4.6\text{ mW.}$$

87. $L_A = 1.0 \text{ H}$; $L_B = 2.0 \text{ H}$; $R = 10 \Omega$

a) $t = 0.1 \text{ s}$, $\tau_A = 0.1$, $\tau_B = L/R = 0.2$

$$i_A = i_0(1 - e^{-t/\tau})$$
$$= \frac{2}{10} \left(1 - e^{\frac{-0.1 \times 10}{1}} \right) = 0.2 (1 - e^{-1}) = 0.126424111$$

$$i_B = i_0(1 - e^{-t/\tau})$$
$$= \frac{2}{10} \left(1 - e^{\frac{-0.1 \times 10}{2}} \right) = 0.2 (1 - e^{-1/2}) = 0.078693$$

$$\frac{i_A}{i_B} = \frac{0.126424111}{0.078693} = 1.6$$

b) $t = 200 \text{ ms} = 0.2 \text{ s}$

$$i_A = i_0(1 - e^{-t/\tau})$$
$$= 0.2(1 - e^{-0.2 \times 10/1}) = 0.2 \times 0.864664716 = 0.172932943$$

$$i_B = 0.2(1 - e^{-0.2 \times 10/2}) = 0.2 \times 0.632120 = 0.126424111$$

$$\frac{i_A}{i_B} = \frac{0.172932943}{0.126424111} = 1.36 = 1.4$$

c) $t = 1 \text{ s}$

$$i_A = 0.2(1 - e^{-1 \times 10/1}) = 0.2 \times 0.9999546 = 0.19999092$$

$$i_B = 0.2(1 - e^{-1 \times 10/2}) = 0.2 \times 0.99326 = 0.19865241$$

$$\frac{i_A}{i_B} = \frac{0.19999092}{0.19865241} = 1.0$$

88. a) For discharging circuit

$$i = i_0 e^{-t/\tau}$$

$$\Rightarrow 1 = 2 e^{-0.1/\tau}$$

$$\Rightarrow (1/2) = e^{-0.1/\tau}$$

$$\Rightarrow \ln(1/2) = \ln(e^{-0.1/\tau})$$

$$\Rightarrow -0.693 = -0.1/\tau$$

$$\Rightarrow \tau = 0.1/0.693 = 0.144 = 0.14.$$

b) $L = 4 \text{ H}$, $i = L/R$

$$\Rightarrow 0.14 = 4/R$$

$$\Rightarrow R = 4 / 0.14 = 28.57 = 28 \Omega.$$

89.

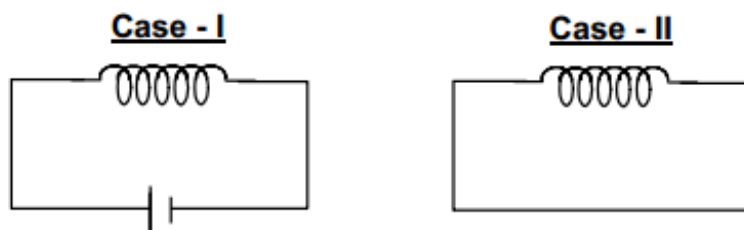

In this case there is no resistor in the circuit.

So, the energy stored due to the inductor before and after removal of battery remains same. i.e.

$$V_1 = V_2 = \frac{1}{2} Li^2$$

So, the current will also remain same.

Thus charge flowing through the conductor is the same.

90. a) The inductor does not work in DC. When the switch is closed the current charges so at first inductor works. But after a long time the current flowing is constant.

Thus effect of inductance vanishes.

$$i = \frac{E}{R_{\text{net}}} = \frac{E}{\frac{R_1 R_2}{R_1 + R_2}} = \frac{E(R_1 + R_2)}{R_1 R_2}$$

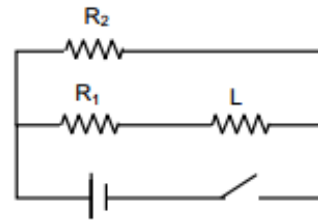

- b) When the switch is opened the resistors are in series.

$$\tau = \frac{L}{R_{\text{net}}} = \frac{L}{R_1 + R_2}$$

91. $i = 1.0 \text{ A}$, $r = 2 \text{ cm}$, $n = 1000 \text{ turn/m}$

$$\text{Magnetic energy stored} = \frac{B^2 V}{2\mu_0}$$

Where $B \rightarrow$ Magnetic field, $V \rightarrow$ Volume of Solenoid.

$$= \frac{\mu_0 n^2 i^2}{2\mu_0} \times \pi r^2 h$$

$$= \frac{4\pi \times 10^{-7} \times 10^6 \times 1 \times \pi \times 4 \times 10^{-4} \times 1}{2} \quad [h = 1 \text{ m}]$$

$$= 8\pi^2 \times 10^{-5}$$

$$= 78.956 \times 10^{-5} = 7.9 \times 10^{-4} \text{ J.}$$

92. Energy density = $\frac{B^2}{2\mu_0}$

$$\text{Total energy stored} = \frac{B^2 V}{2\mu_0} = \frac{(\mu_0 i / 2r)^2}{2\mu_0} V = \frac{\mu_0 i^2}{4r^2 \times 2} V$$

$$= \frac{4\pi \times 10^{-7} \times 4^2 \times 1 \times 10^{-9}}{4 \times (10^{-1})^2 \times 2} = 8\pi \times 10^{-14} \text{ J.}$$

93. $I = 4.00 \text{ A}$, $V = 1 \text{ mm}^3$,
 $d = 10 \text{ cm} = 0.1 \text{ m}$

$$\bar{B} = \frac{\mu_0 i}{2\pi r}$$

Now magnetic energy stored = $\frac{B^2}{2\mu_0} V$

$$= \frac{\mu_0^2 i^2}{4\pi r^2} \times \frac{1}{2\mu_0} \times V = \frac{4\pi \times 10^{-7} \times 16 \times 1 \times 1 \times 10^{-9}}{4 \times 1 \times 10^{-2} \times 2}$$

$$= \frac{8}{\pi} \times 10^{-14} \text{ J}$$

$$= 2.55 \times 10^{-14} \text{ J}$$

94. $M = 2.5 \text{ H}$

$$\frac{dl}{dt} = \frac{\ell A}{s}$$

$$E = -\mu \frac{dl}{dt}$$

$$\Rightarrow E = 2.5 \times 1 = 2.5 \text{ V}$$

95. We know

$$\frac{d\phi}{dt} = E = M \times \frac{di}{dt}$$

From the question,

$$\frac{di}{dt} = \frac{d}{dt}(i_0 \sin \omega t) = i_0 \omega \cos \omega t$$

$$\frac{d\phi}{dt} = E = \frac{\mu_0 a i_0 \omega \cos \omega t}{2\pi} \ell n[1 + a/b]$$

Now, $E = M \times \frac{di}{dt}$

or, $\frac{\mu_0 a i_0 \omega \cos \omega t}{2\pi} \ell n[1 + a/b] = M \times i_0 \omega \cos \omega t$

$$\Rightarrow M = \frac{\mu_0 a}{2\pi} \ell n[1 + a/b]$$

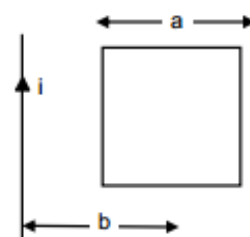

96. emf induced = $\frac{\pi \mu_0 N a^2 a'^2 E R V}{2L(a^2 + x^2)^{3/2} (R/Lx + r)^2}$

$$\frac{di}{dt} = \frac{E R V}{L \left(\frac{R x}{L} + r \right)^2} \quad (\text{from question 20})$$

$$\mu = \frac{E}{di/dt} = \frac{N \mu_0 \pi a^2 a'^2}{2(a^2 + x^2)^{3/2}}$$

97. **Solenoid I :**

$$a_1 = 4 \text{ cm}^2 ; n_1 = 4000/0.2 \text{ m} ; \ell_1 = 20 \text{ cm} = 0.20 \text{ m}$$

Solenoid II :

$$a_2 = 8 \text{ cm}^2 ; n_2 = 2000/0.1 \text{ m} ; \ell_2 = 10 \text{ cm} = 0.10 \text{ m}$$

$B = \mu_0 n_2 i$ let the current through outer solenoid be i .

$$\phi = n_1 B \cdot A = n_1 n_2 \mu_0 i \times a_1$$

$$= 2000 \times \frac{2000}{0.1} \times 4\pi \times 10^{-7} \times i \times 4 \times 10^{-4}$$

$$E = \frac{d\phi}{dt} = 64\pi \times 10^{-4} \times \frac{di}{dt}$$

$$\text{Now } M = \frac{E}{di/dt} = 64\pi \times 10^{-4} \text{ H} = 2 \times 10^{-2} \text{ H.} \quad [\text{As } E = M di/dt]$$

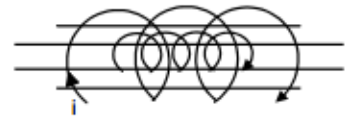

98. a) B = Flux produced due to first coil

$$= \mu_0 n i$$

Flux ϕ linked with the second

$$= \mu_0 n i \times NA = \mu_0 n i N \pi R^2$$

Emf developed

$$= \frac{d\phi}{dt} = \frac{dt}{dt} (\mu_0 n i N \pi R^2)$$

$$= \mu_0 n N \pi R^2 \frac{di}{dt} = \mu_0 n N \pi R^2 i_0 \omega \cos \omega t .$$